

Building Drawing – 1

Main parts of a One Storied Building

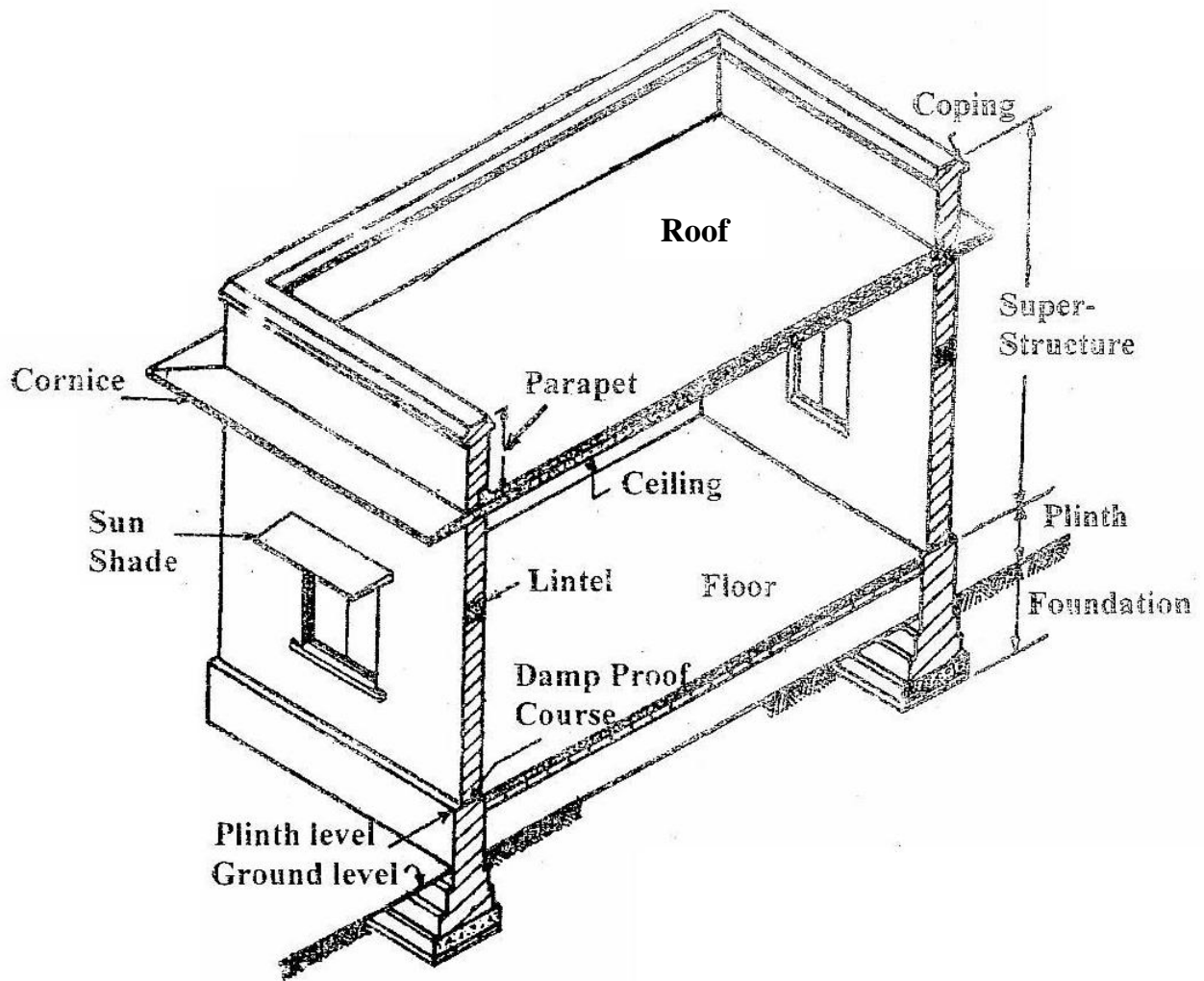

Isometric View of a One Storied Building

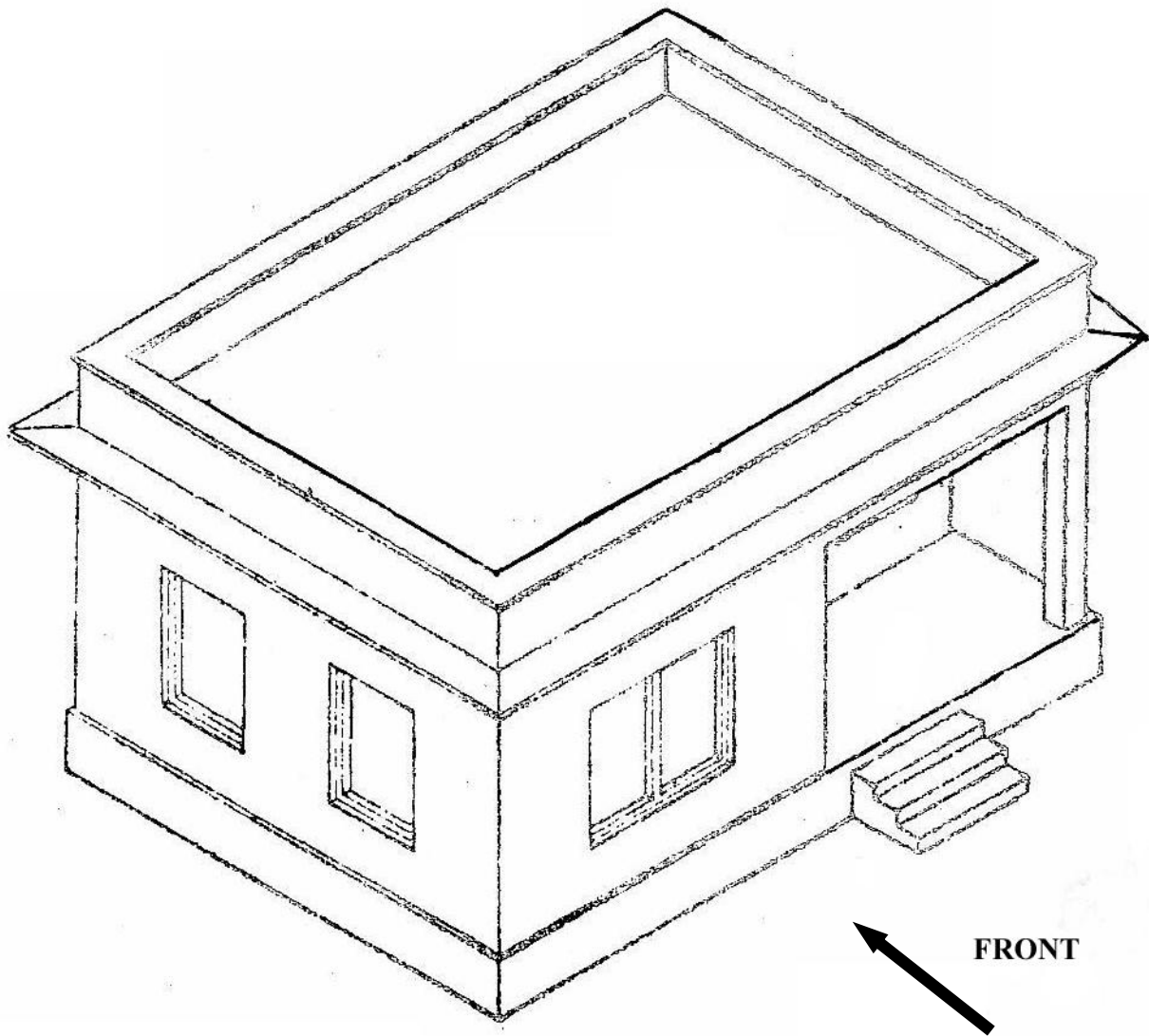

A horizontal section is cut at the mid height of the windows, to get the plan of the building

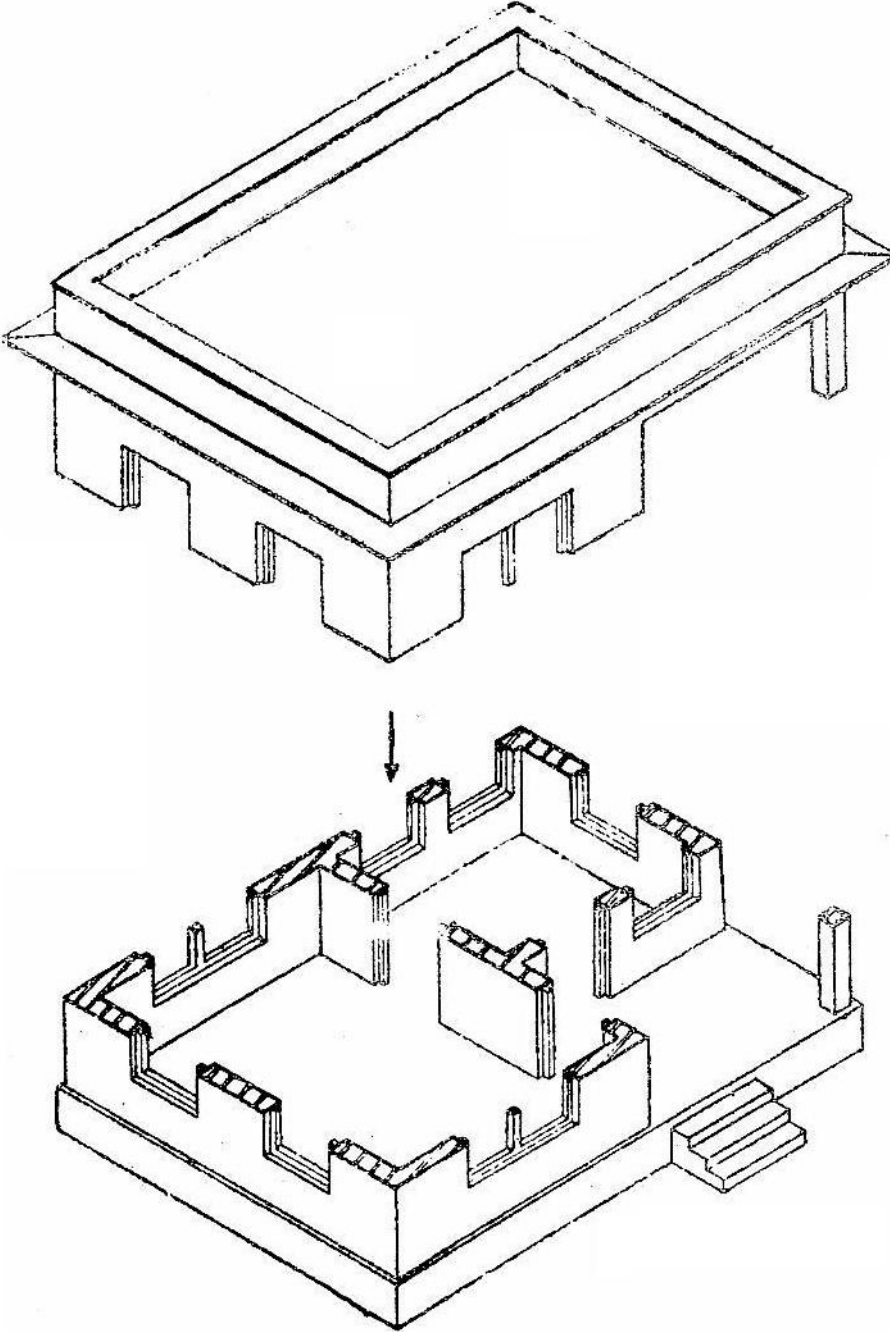

A vertical section is cut to get the Front Sectional Elevation

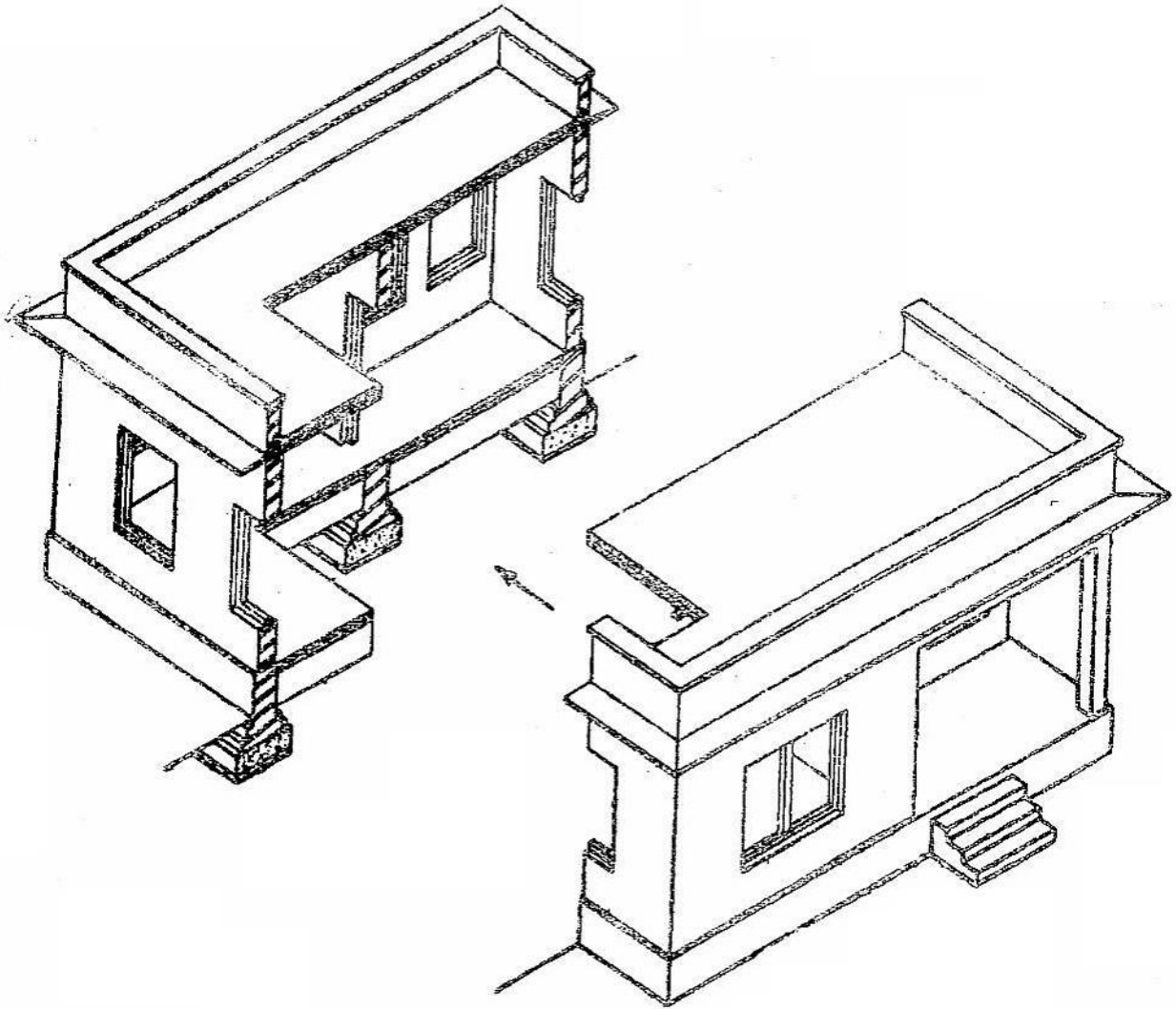

Drawing of Doors and Windows – illustrating their opening direction

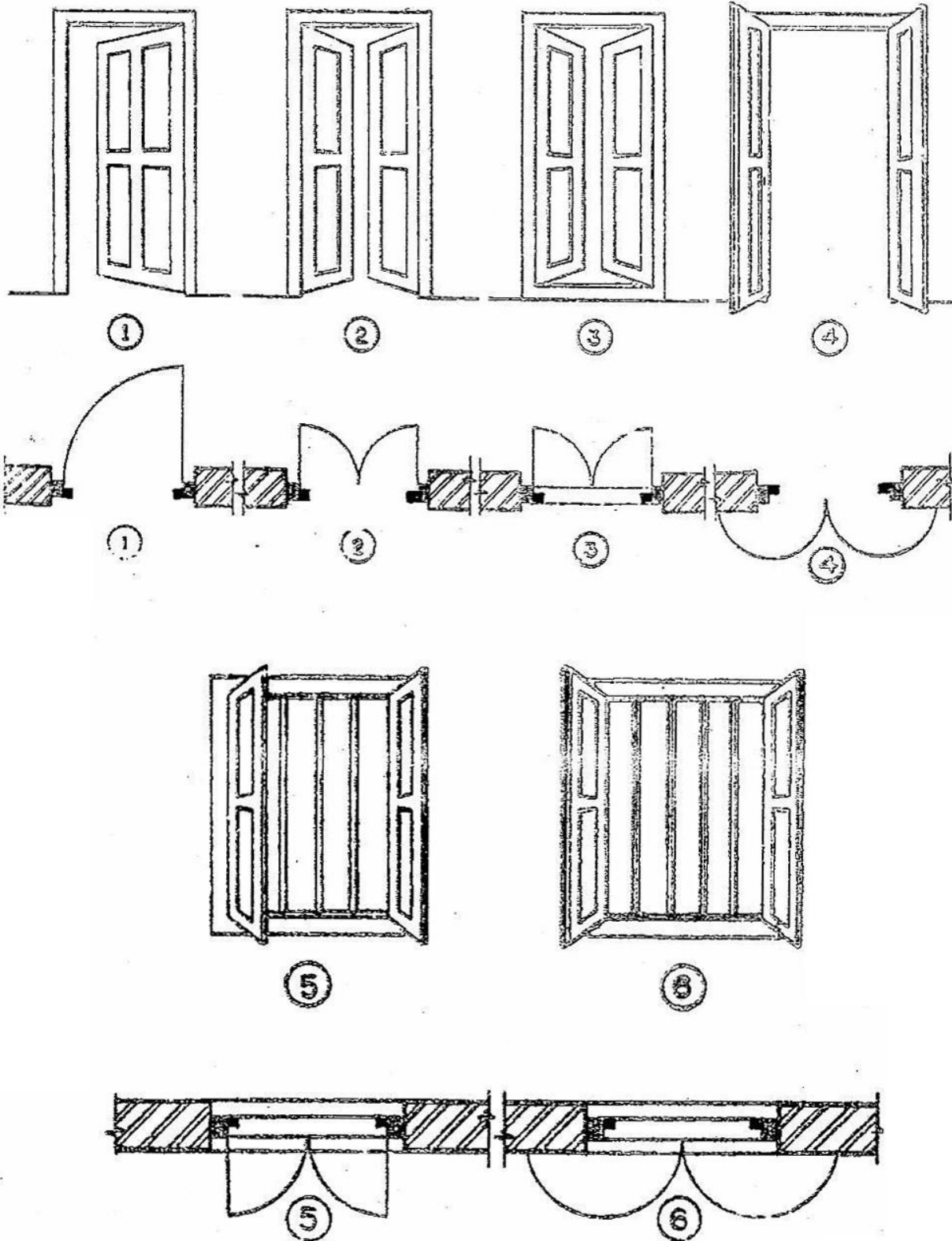

Conventions

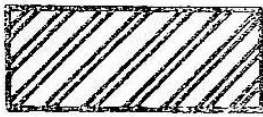

(1)

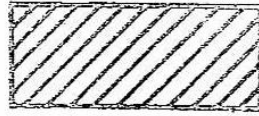

(2)

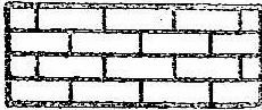

(3)



(4)



(5)

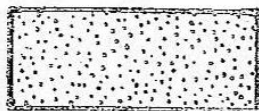

(6)



(7)



(8)



(9)

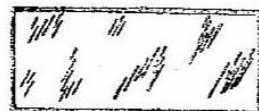

(10)

(1) or (2) Masonry Section
Used in Elevation

(3) or (4) Masonry Pointing
Used in Elevation

(5) Concrete Section
Used in Plan or Elevation

(6) Plaster or brick concrete section
Used in Plan or Elevation

(7) Wood Section, having the section at
right angle of the fiber
Used in Plan or Elevation

(8) Wood Section taken along the length
of the fiber
Used in Plan or Elevation

(9) Soil
Used in Elevation

(10) Glass
Used in Elevation



WOOD